











FAROS 1 BRASS

276

- Διακοσμητικός προβολέας στεγανός από χυτό ορείχαλκο
- με υάλινο προστατευτικό tempered πάχους 5mm διάφανο ή ματ
- με βίδες inox
- ελαστικά στεγανοποίησης από σιλικόνη
- με 1 ή 2 στιπιοθλίπτες PGII IP68
- κατάλληλος για εξωτερικό φωτισμό, οικιών, κήπων
- Προσφέρεται με καρφωτό στήριγμα εδάφους χυτό ορείχαλκινο, κωδ. 5284.

- Decorative waterproof projector
- made from brass
- with tempered glass 5mm thick transparent or mat
- with inox screws
- silicon gaskets
- with 1 or 2 brass nickel plated cable glands PGII IP68
- suitable for external lighting of shops, houses, gardens
- Available with spike for ground fixing made from brass, code 5284.

- | | | | |
|-------------|--|-----------------------------------|---|
| 3625 |  | DICHROIC
12V 50W GU5,3 |  |
| 3626 |  | DICHROIC
230V 50W GU10 |   |
| 3627 |  | COMPACT REFLECTOR
230V 7W GU10 |   |
| 5284 | <ul style="list-style-type: none"> ▸ Καρφωτό στήριγμα εδάφους χυτό ορείχαλκινο. ▸ Spike for ground fixing made from brass. | | |

GLASS (5mm) CE 



ΜΠΛΕ/BLUE: 5291-06 ΠΡΑΣΙΝΟ/GREEN: 5291-08
ΚΟΚΚΙΝΟ/RED: 5291-14 ΚΙΤΡΙΝΟ/YELLOW: 5291-32

- Προσφέρεται και με έγχρωμα γυαλιά tempered πάχους 5mm
- Available with colored tempered glasses 5mm thick

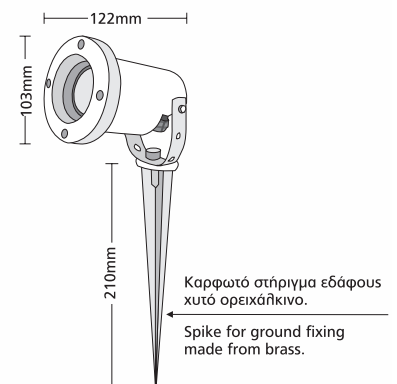

Προσφέρονται και για λυχνίες MR16 LED ή GU10 LED σε διάφορα χρώματα
Available also for MR16 LED or GU10 LED lamps at different colors