









7401  CDM-R 230V
35W E27 (HQI)   

7402  CDM-R 230V
70W E27 (HQI)   

GLASS (4mm)  

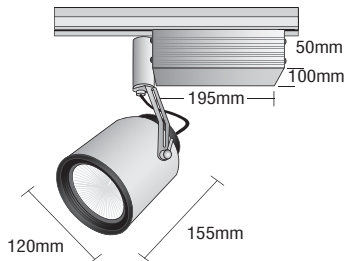

- ▶ Διακοσμητικός προβολέας εσωτερικού χώρου
- ▶ χυτό αλουμινίου
- ▶ περιστρεφόμενος με οριζόντια και κάθετη κίνηση
- ▶ με υάλινο προφυλακτήρα tempered διάφανο ή ματ πάχους 4mm
- ▶ με σετ έναυσης HQI 35W-70W εντός διακοσμητικού κιβωτίου από προφίλ αλουμινίου κατάλληλου για τοποθέτηση σε τριφασική ράγα
- ▶ κατάλληλος για φωτισμό καταστημάτων, βιτρινών, εκθεσιακών χώρων.
- ▶ Decorative projector
- ▶ for indoors use
- ▶ from die cast aluminum
- ▶ adjustable with horizontal and vertical movement
- ▶ with tempered glass transparent or mat 4mm thick
- ▶ with HQI gear box 35W-70W in decorative aluminum profile box suitable for three phase track
- ▶ for use at shops, shop windows, showrooms.

7960  HCI-TC
230V 35W G8.5   

7961  HCI-TC
230V 70W G8.5   

GLASS (4mm)  

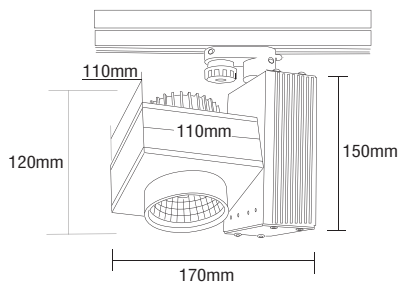

- ▶ Διακοσμητικός προβολέας εσωτερικού χώρου
- ▶ χυτό αλουμινίου,
- ▶ περιστρεφόμενος με κάθετη και οριζόντια κίνηση
- ▶ με υάλινο προφυλακτήρα tempered διάφανο ή ματ πάχους 4mm
- ▶ με ενσωματωμένο ηλεκτρονικό σύστημα έναυσης εντός κιβωτίου από χυτό αλουμίνιο
- ▶ κατάλληλος για τοποθέτηση σε τριφασική ράγα
- ▶ για φωτισμό καταστημάτων, βιτρινών, εκθεσιακών χώρων κλπ.
- ▶ Decorative projector for indoors use
- ▶ from die cast aluminum
- ▶ adjustable with horizontal and vertical movement
- ▶ with tempered glass transparent or mat 4mm thick
- ▶ with incorporated electronic gear box in decorative die cast aluminium box suitable for three phase track
- ▶ for use at shops, shop windows, showrooms

9424  HCI-TC
230V 35W G8.5   

9425  HCI-TC
230V 70W G8.5   

GLASS (4mm)  

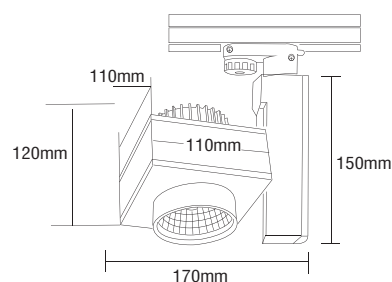

- ▶ Διακοσμητικός προβολέας εσωτερικού χώρου
- ▶ χυτό αλουμινίου,
- ▶ περιστρεφόμενος με κάθετη και οριζόντια κίνηση
- ▶ με υάλινο προφυλακτήρα tempered διάφανο ή ματ πάχους 4mm
- ▶ με ενσωματωμένο ηλεκτρονικό σύστημα έναυσης εντός κιβωτίου από χυτό αλουμίνιο
- ▶ κατάλληλος για τοποθέτηση σε τριφασική ράγα
- ▶ για φωτισμό καταστημάτων, βιτρινών, εκθεσιακών χώρων κλπ.
- ▶ Decorative projector
- ▶ for indoors use from die cast aluminum
- ▶ adjustable with horizontal and vertical movement
- ▶ with tempered glass transparent or mat 4mm thick
- ▶ with incorporated electronic gear box in decorative die cast aluminium box suitable for three phase track
- ▶ for use at shops, shop windows, showrooms

8445  HALLOSPOT 70
230/12V 50W Ba15d   

GLASS (4mm)  

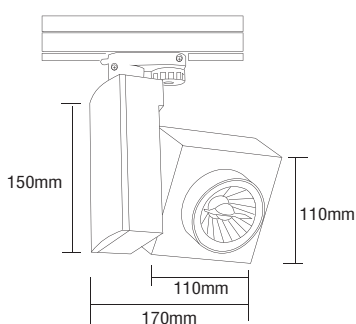

- ▶ Διακοσμητικός προβολέας εσωτερικού χώρου
- ▶ χυτό αλουμινίου, περιστρεφόμενος με κάθετη και οριζόντια κίνηση
- ▶ με ενσωματωμένο ηλεκτρονικό σύστημα έναυσης εντός κιβωτίου από χυτό αλουμίνιο
- ▶ κατάλληλος για τοποθέτηση σε τριφασική ράγα για φωτισμό καταστημάτων, βιτρινών, εκθεσιακών χώρων κλπ.
- ▶ Decorative projector
- ▶ for indoors use
- ▶ from die cast aluminum
- ▶ adjustable with horizontal and vertical movement
- ▶ with incorporated electronic gear box in decorative die cast aluminium box suitable for three phase track
- ▶ for use at shops, shop windows, showrooms

TUBE SYSTEM I I



CUBIC BOX I



CUBIC BOX 2



CUBIC BOX 3

