





























|             |   |                                      |   |         |
|-------------|---|--------------------------------------|---|---------|
| <b>5814</b> |  | HQL-T 230V<br>35W G12                |    | H:200mm |
| <b>5815</b> |  | HQL-T 230V<br>70W G12                |    | H:200mm |
| <b>5816</b> |  | HQL-T 230V<br>150W G12               |    | H:200mm |
| <b>5817</b> |  | HQL-TS<br>230V 70W<br>Rx7s           |    | H:185mm |
| <b>5818</b> |  | CDM-R111<br>230V 35W<br>Gx10 (HQL)   |     | H:155mm |
| <b>5899</b> |  | CDM-R111<br>230V 70W<br>Gx10 (HQL)   |     | H:155mm |
| <b>5819</b> |  | HISPOE Es111<br>230V 75-100W<br>Gu10 |     | H:140mm |
| <b>5820</b> |  | HALLOSPOT R111 12V<br>50-75-100W G53 |    | H:120mm |

∅ 166mm  158mm ↓ 120-200mm  





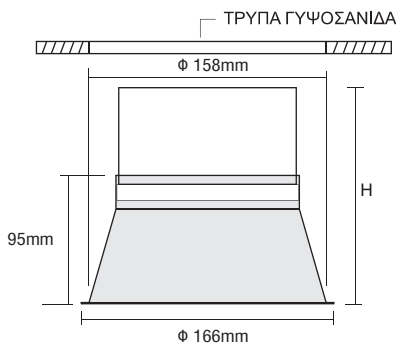























- ▶ Διακοσμητικό σποτ χωνευτό οροφής
- ▶ εσωτερικού χώρου
- ▶ χυτό αλουμινίου
- ▶ σταθερό
- ▶ κατάλληλο για φωτισμό καταστημάτων, γραφείων, οικιών.

- ▶ Decorative recessed spotlight
- ▶ for indoors use
- ▶ from die cast aluminum
- ▶ fixed
- ▶ for use at shops, houses, offices

## LIP MED 1



|             |   |                                      |   |         |
|-------------|---|--------------------------------------|---|---------|
| <b>5821</b> |  | HQL-T 230V<br>35W G12                |    | H:210mm |
| <b>5822</b> |  | HQL-T 230V<br>70W G12                |    | H:210mm |
| <b>5823</b> |  | HQL-T 230V<br>150W G12               |    | H:210mm |
| <b>5824</b> |  | HQL-TS<br>230V 70W<br>Rx7s           |    | H:185mm |
| <b>5825</b> |  | CDM-R111<br>230V 35W<br>Gx10 (HQL)   |     | H:165mm |
| <b>9100</b> |  | CDM-R111<br>230V 70W<br>Gx10 (HQL)   |     | H:165mm |
| <b>5826</b> |  | HISPOE Es111<br>230V 75-100W<br>Gu10 |     | H:150mm |
| <b>5827</b> |  | HALLOSPOT R111 12V<br>50-75-100W G53 |    | H:135mm |

∅ 195mm  185mm ↓ 120-200mm  



Κινητή Λαμπιοθήκη  
Movable Lampholder

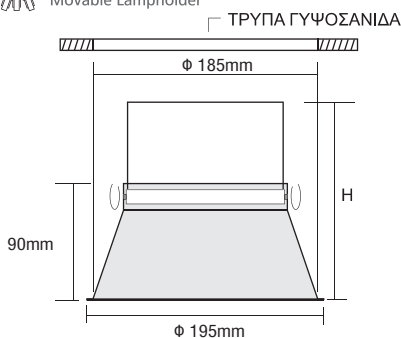

- ▶ Διακοσμητικό σποτ χωνευτό οροφής
- ▶ εσωτερικού χώρου
- ▶ χυτό αλουμινίου
- ▶ κινητό
- ▶ κατάλληλο για φωτισμό καταστημάτων, γραφείων, οικιών

- ▶ Decorative recessed spotlight
- ▶ for indoors use
- ▶ from die cast aluminum
- ▶ movable
- ▶ for use at shops, houses, offices

## LIP MED 2



Τα παραπάνω φωτιστικά είναι κατάλληλα για λαμπνίες LED R111 ή ES111.  
The above fittings are suitable for R111 LED or ES111 led lamps.

Βαμμένα με Πολυεστερική Ηλεκτροστατική Βαφή  
Painted with Polyester Electrostatic Powder

01 02 18

