









ORBITER

7135  HQL-T
230V 250W E40   7136  HQL-T
230V 400W E40   CE 

- ▶ Διακοσμητικό κρεμαστό φωτιστικό
- ▶ τύπου καμπάνας
- ▶ για τοποθέτηση στην οροφή με ντίζα ή συρματοσόχοινο,
- ▶ με ενσωματωμένο σετ έναυσης λυχνιών
- ▶ και ανακλαστήρα αλουμινίου υψηλής απόδοσης φωτισμού



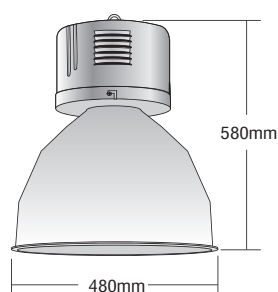





- ▶ Decorative ceiling pendant light
- ▶ with suspension rod or wire-rod suspension
- ▶ with incorporated gear box for the lamps
- ▶ and aluminum reflector
- ▶ of high lighting efficiency

Αξεσουάρ/ Accessory

- ▶ Η καμπάνα ORBITER προσφέρεται με υάλινο προφυλακτήρα tempered και προστατευτικό μεταλλικό δακτύλιο ΚΩΔ. 5110
- ▶ The ORBITER fitting is available with tempered glass and securing metal ring CODE 5110

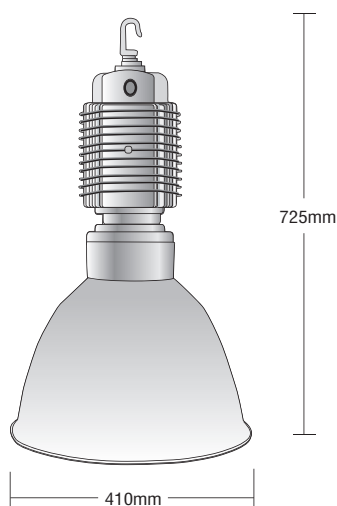

ATLANTIC 7

7100  HQL 230V
70W E27   7101  HQL 230V
150W E27   7137  HQL-T
230V 250W E40   CE 

- ▶ Διακοσμητικό κρέμαστο φωτιστικό
- ▶ τύπου καμπάνας
- ▶ για τοποθέτηση στην οροφή με ντίζα ή συρματοσόχοινο,
- ▶ με βάση χυτή αλουμινίου
- ▶ με ενσωματωμένο σετ έναυσης λυχνιών
- ▶ και ανακλαστήρα αλουμινίου υψηλής απόδοσης φωτισμού

- ▶ Decorative ceiling pendant light
- ▶ with suspension rod or wire-rod suspension
- ▶ with die cast aluminum base
- ▶ with incorporated gear box for the lamps
- ▶ and aluminum reflector
- ▶ of high lighting efficiency



829