

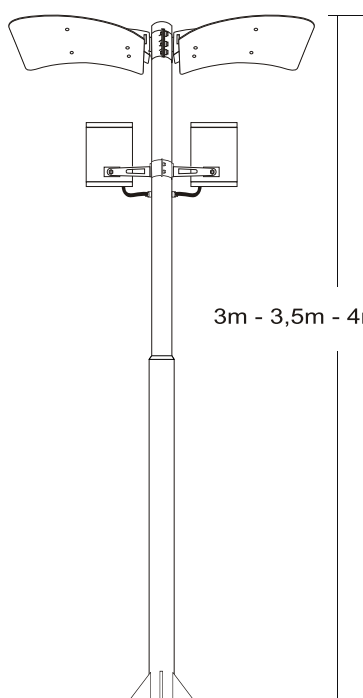





## TOWER 5.3







3m - 3,5m - 4m - 4,5m

- ▶ Φωτιστικό στεγανό για εξωτερικούς χώρους
- ▶ με σιδερένιο ιστό διαμέτρου  $\Phi 133\text{mm}$  και πάχους 4mm
- ▶ με 2 εξωτερικό ανακλαστήρα αλουμινίου για έμμεσο φωτισμό
- ▶ με 2 προβολέα στεγανό Ip65 κατάλληλο για λυχνίες HQI 70-150W
- ▶ με ενσωματωμένο σετ έναύσης HQI 70-150W για φωτισμό εξωτερικών χώρων κτιρίων, πάρκων, δρόμων.

- ▶ Waterproof fitting outdoors use
- ▶ with pressed steel pillar of  $\Phi 133\text{mm}$  external diameter with thickness 4mm
- ▶ with 2 external aluminium reflector for indirect lighting
- ▶ with 2 waterproof projector suitable for HQI lamps 70-150W
- ▶ with incorporated gear box HQI 70-150W for use at public places, for external lighting of building roads.

**26002**  HQI-T 230V  
2x70W G12   

**26003**  HQI-T 230V  
2x150W G12   

CE 