

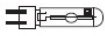



























Tube Maxi 3 Projector MH

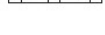

- Προβολέας led στεγανός
 - αλουμινίου βαρέως τύπου
 - ηλεκτροστατικά βαμμένος με πολυεστερική πούδρα
 - κατάλληλη για εξωτερικούς χώρους
 - με υάλινο προφυλακτήρα tempered πάχους 6mm διάφανο ή ματ
 - κατάλληλος για λυχνίες metal halide
 - με ανακλαστήρα αλουμινίου υψηλής απόδοσης
 - με δέσμη 15°-25°-40°-60°
 - λειτουργεί με ενσωματωμένο ηλεκτρονικό σύστημα έναυσης
 - με ελαστικά στεγανοποίησης από σιλικόνη
 - στιπιοθλίπτη Pg 9 από πολυαμίδα IP68
 - και βίδες Inox
 - κατάλληλος για φωτισμό αρχιτεκτονικών λεπτομερειών, κτιρίων, καταστημάτων
-
- Waterproof led projector
 - for outdoors use
 - from heavy duty die cast aluminum
 - painted with electrostatic polyester powder
 - suitable for external use
 - with tempered glass transparent or mat, 6mm thick
 - suitable for metal halide lamps
 - with high performance aluminum reflector
 - available with 15°-25°-40°-60° beam
 - with incorporated/built in metal halide electronic gear
 - with silicon gaskets
 - polyamide cable gland Pg 9 Ip68
 - and inox screws
 - suitable for decorative lighting of architectural details such building and shop facades

27685		HCI-TC 230V 50W G8.5	  
27686		HQT-T 230V 35W G12	  
27140		HCI-TC 230V 35W G8.5	  
27141		HQT-T 230V 50W G12	  
27142		HCI-TC 230V 70W G8.5	  
27143		HQT-T 230V 70W G12	  
27144		HQT-TC 230V 70W Rx7s	  

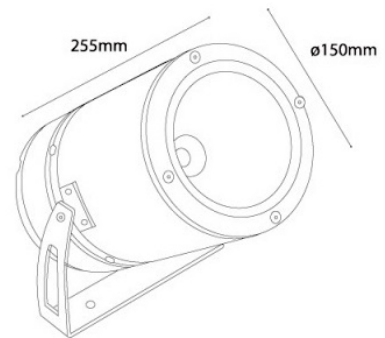

GLASS (6mm) CE IP65

5075
ΚΑΡΩΤΟ ΣΤΗΡΙΓΜΑ ΕΔΑΦΟΥΣ ΑΛΟΥΜΙΝΙΟΥ
ALUMINUM GROUND SPIKE
L=305mm

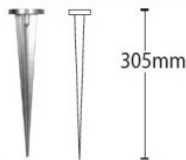

5201
ΕΞΩΤΕΡΙΚΟ ΣΤΗΡΙΓΜΑ ΑΛΟΥΜΙΝΙΟΥ
GROUND SURFACED ALUMINUM SUPPORT
L=305mm

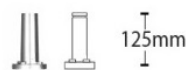

5076
ΚΙΤ ΣΤΗΡΙΞΗΣ ΑΛΟΥΜΙΝΙΟΥ
SUPPORTING ALUMINUM KIT
L=430mm

