













- Φωτιστικό εξωτερικό στεγανό επίτοιχο
- κατάλληλο για χρήση εξωτερικούς χώρους
- από σώμα χυτό αλουμινίου και στεφάνι χυτό αλουμινίου
- βαμμένα ηλεκτροστατικά με πολυεστερική πούδρα
- για αντοχή σε καταπονήσεις του εξωτερικού περιβάλλοντος
- με 2 υάλινους προφυλακτήρες tempered πάχους 4mm
- με ελαστικά στεγανοποίησης και βίδες inox
- με ενσωματωμένη λυχνιολαβή πορσελάνης E27
- ή με ενσωματωμένο ballast κατάλληλο για λυχνίες φθορισμού

- Waterproof external wall surface luminaire
- suitable for outdoors use
- from die cast aluminum body and flange
- painted with polyester electrostatic powder
- for resistance under harsh environmental conditions
- with 2 protective tempered glasses 4mm thick
- with waterproof gasket and inox screws
- with porcelain lampholder E27
- or with built in ballast suitable for compact fluorescent lamps

26839		1x40W 220-240v E27	
4222		1x18W DULUX-D G24-d2	
4223		1x26W DULUX-D G24-d3	
26840		1x18W DULUX-DE G24-q2	
26841		1x26W DULUX-DE G24-q3	

GLASS (4mm)  

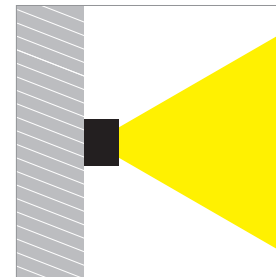
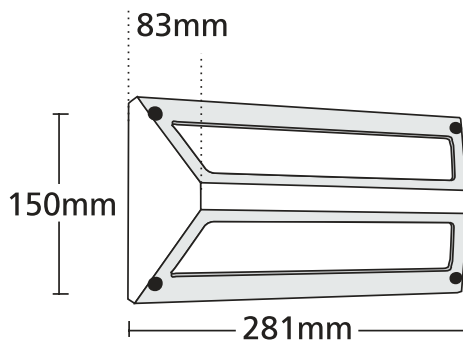
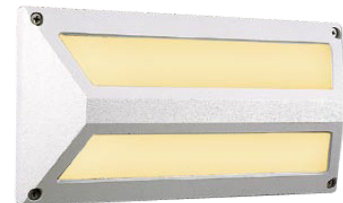

01 02 05 18 30

Βαμμένα με Πολυεστερική Ηλεκτροστατική Βαφή
Painted with Polyester Electrostatic Powder



*Η τεχνολογία των LED είναι σε διαρκή εξέλιξη οπότε πριν παραγγείλετε, παρακαλούμε επιβεβαιώστε ποιο LED είναι διαθέσιμο
LED technology changes constantly forward, so before selecting / ordering the most suitable product for you,
ask for a confirmation that this is the most updated product to our list.

 warm 2700 Kelvin  warm white 3000 Kelvin  neutral white 4000 Kelvin