





- > Σποτ χωνευτό σε γυψοσανίδα
 - > χωρίς εξωτερικό πλαίσιο
 - > με βαθμό στεγανότητας IP65
 - > χυτό αλουμινίου
 - > κατάλληλο για darklight (αντιθαμβωτικό) φωτισμό
 - > σταθερό
 - > κατάλληλο για λυχνίες τύπου MR16
 - > 12volt GU5.3 ή 230-240volt GU10
 - > με προστατευτικό υάλινο προφυλακτήρα
 - > tempered διάφανο
-
- > Recessed false ceiling spot
 - > frameless/trimless
 - > with IP65 protection
 - > from die cast aluminum
 - > suitable for darklight (anti-dazzle) effect
 - > fixed
 - > suitable for lamps type MR16
 - > 12volt GU5.3 or 230-240volt GU10
 - > with transparent tempered glass

40434 LED LAMP MR16 GU10 220-240V 3-8W **REF 1** 

40435 LED LAMP MR16 12V 3-8W **REF 3** 

∅ 76mm  77mm  125mm  

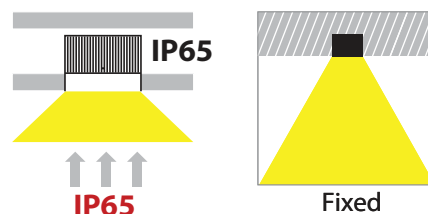
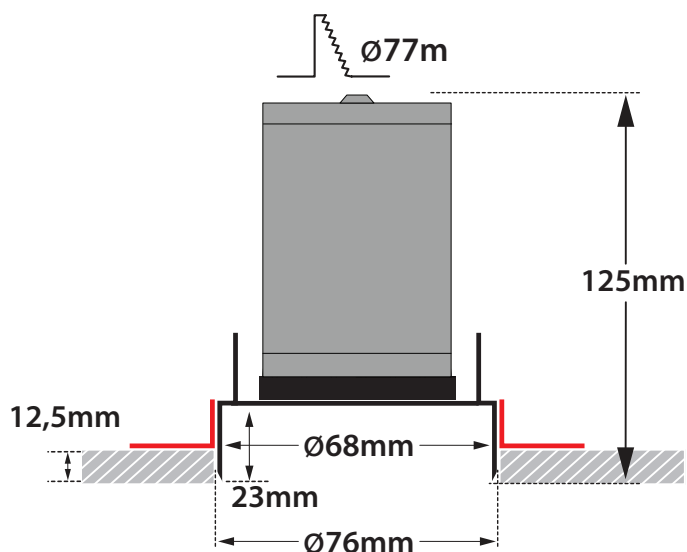
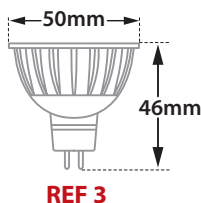
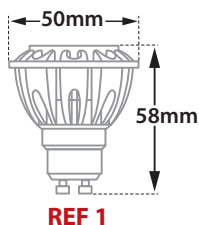

Accessories upon request

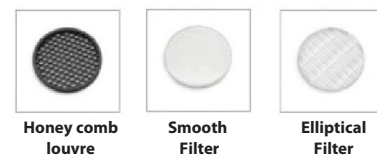

Ρυθμιζόμενα πλαϊνά στηρίγματα για οροφές πάχους από 10mm έως 30mm

Adjustable side brackets for installation onto ceiling with thickness from 10mm up to 30mm