

2023

**MP**ILLUMINATION  
MARINOS PATRIKIOS ARCHITECTURAL LIGHTING

**SINCE**  
**1973**

*is based on the excellent  
high-end engineering, the  
modern aesthetic designs.  
ng according to the latest  
Our partners-suppliers are  
we make sure our products  
ts are top lighting projects  
recognized internationally.*

**LIGHTING**  
KNOW HOW

---

SINCE 1973

VISIT NOW  
OUR WEBSITE  
JOIN US AND  
STAY INFORMED  
ON OUR  
NEW PRODUCTS!

[WWW.MPILLUMINATION.COM](http://WWW.MPILLUMINATION.COM)



WHO  
WE ARE

WE MANUFACTURE AND CUSTOMIZE ARCHITECTURAL INDOOR AND OUTDOOR LIGHTING FIXTURES

Operating since 1973, our continuous evolution is based on the excellent knowledge of lighting technology, the use of high-end engineering, the application of safety standards and the modern aesthetic designs.

We design and manufacture architectural lighting according to the latest developments and technological achievements. Our partners-suppliers are international market leaders and trend setters and we make sure our products incorporate high-end elements, whereas our clients are top lighting projects companies, architectural companies and engineers recognized internationally.

Our production line consists of more than fifteen categories, and covers the complete range of indoor and outdoor luminaires, ideal for every demanding application, such as company offices, commercial centers, museums, airports, hospitals, public buildings, hotels, educational institutions, modern residences, public spaces, streets, ships, factories. Our central offices, showroom and factory are situated in Athens, at Skaramangas industrial area, in privately owned premises of 7.000m<sup>2</sup>.

# BEING SOCIAL

Wherever you access the new site, computer or mobile device, new content, stimulating images, extensive product information, and so much more are there to explore.

Our new product search engine either you know what product you need or not, guides you to the right product page. Download or send us a request for a specification sheet. Check our latest projects for an inspiration. Sign to our monthly newsletter and stay informed on our latest news. Use the "myMPlists" a free, non-registration required business tool that we built just for you. You can pin all your "product likes" and share them with anyone involved in your project. Login or register for you to access extra features such as multiple and editable pinlists.

# CONTINUOUS EVOLUTION

*WE ARE MOTIVATED TO OFFER QUALITY, TO ASSEMBLE TECHNOLOGICAL PROGRESS AND TO MEET MODERN TRENDS TO OUR LIGHTING SOLUTIONS FOR ANY SPACE AND PROJECT STANDARDS*

During the years, we created a network of many important customers like wholesalers, architects and technical companies all over Greece. We gradually expanded our activities in more than 40 countries all over the world, forming strong business relations with many lighting importers and designers, thanks to whom we have the honor of being in the list of approved manufacturers in many prestigious lighting projects worldwide.

We strongly believe in relationships and bonds created, while we are constantly motivated to maintain and increase the high quality of our fixtures and we are proud to satisfy our customers most demanding inquiries.



# MORE THAN 46 YEARS OF EXPERIENCE IN LIGHTING

*Over the last 46 years in lighting business we acknowledge that the key of success is based on some important values: Professionalism, attention to detail, fairness, flexibility, service and speed. Our philosophy is based on these values and has led us to build strong partnerships through the years.*

## 100% GREEK PRODUCTS

The production process is conducted in our privately owned premises in Athens: from manufacturing and assembling to wiring and final testing. We don't just assemble the luminaires but we carry out the whole process from RND stages to final product. This allows us to make prototypes and made-to-measure fixtures rapidly and with excellent quality standards. This is one of our strong competitive advantages in the international market.

## DESIGN

When we design & develop our new collections, we are inspired by trends in architecture, we are driven by the progress of technology and we are focused on the international markets' needs. The design of every new product perceives all

the elements of the fitting, as shape, material, functionality, flexibility and technology, in a way to create added value for all parties involved in lighting either by selling, specifying, installing or just enjoying the light result. Our designing department is structured to develop new standard products and custom-made fittings to satisfy all kind of demands.

## EXTENDED GUARANTEE

The standard guarantee of a wide range of our products is extended up to 5 years, upon official request for special projects. This is the reason we use top quality accessories and electronic components (leds, led drivers) from the world's leading companies, as also branded heat dissipation and quality control systems, to achieve the best results in performance and life duration.

## VALUE & PRICE

Our products are considered as a good value for money choice. We give great consideration to quality and price equation. Continuous cost analysis allows us to improve production process at all stages, so as to offer the best possible prices without any compromise in quality, design or technology. Special prices for projects are achieved after negotiation with our suppliers, making it possible to compete, always following projects specifications and photometric needs.

## SPEED & FLEXIBILITY

We work promptly with respect to time constrains. Our experience in various projects and investment in technology and production line, give us the advantages to do so. The coordination between departments (sales, design, production, logistics) and well-organized management makes it possible to deliver in just a few days for smaller projects to few weeks for bigger ones according to project's time requirements.

## RESEARCH & DEVELOPMENT

We make high investment to support the RND, as our product line is entirely developed within the company, from the design phase to the prototype, from the thermal and photometric analysis to the optics design and components selection. Our constant guideline is to follow up with quality and lighting performance excellence.

## CUSTOMIZATION

Our technical team can offer you the best solution to your project's needs. We have all the tools to do so. Technical skills, intelligent innovation and manufacture knowhow enable us to respond to your requirements in a short time. We are on your side, as we have the resources and experience to manufacture quality customized solutions to order.

## VARIETY

We provide one-stop shopping solution for your projects. Our catalogues and website include thousands of items, offer a wide range of products for indoors and outdoors use, contain impressive combinations of materials, colors and versions. Our goal is for you to find a product in our list that enhances your style and fulfills your requirements.

## LED TECHNOLOGY

We follow up the constantly evolving LED technology. We believe and invest in new technologies, so much that today more than 95% of the full range is available in LED version. Thanks to technology progress the latest led modules are very powerful and ensure better efficiency, lower consumption, higher reliability and long life duration. Our led collection makes it possible for lighting designers to create different lighting scenes, from accentuation to ambient, wall washing, orientation or open area lighting, selecting from a wide range of beams, filters, lenses and other accessories. We use high-power LEDs and Chip-on-Board LED (COB).

This provides an advantage to the end user to obtain the highest lumen output and most suitable light engine for the application. The high quality of LEDs supplied with luminaires in conjunction with the highest efficiency lens and optical systems we use provide a great distribution variety in the industry.

## LIGHTING STUDIES & PLANNING

Our Lighting Design team provides to our clients unique lighting and photometric studies. Combining extensive product knowledge with a wide range of energy efficient product solutions, LD team is able to guide you through a cost-effective and sustainable selection process, without compromising in the quality and lighting result.

## LIGHTING DESIGN TEAM

Our team of lighting designers have been working for many years in the field of lighting design and are able to provide lighting services for interior and exterior environments from concept design through construction completion. Along the way we are able to offer to our clients many specialized and tailored services to suit project needs, working closely with the architectural team. We ensure that our designs are documented thoroughly via AUTOCAD, RELUX and other specialized lighting design programs, as needed for each project. Our luminaires specifications are detailed and extensive, providing the client, design team and contracting team with clear direction for fixture selection.

# OUR FACTORY

## CERTIFICATES

The lighting fittings of MP ILLUMINATION are manufactured, checked and tested in compliance to the general standard of European Union for lighting fittings EN-60598 and they are CE marked on their bodies and packing boxes.

Besides, MP ILLUMINATION has been certified with ISO 9001 from DQS Germany, for the quality management system of its internal processes.

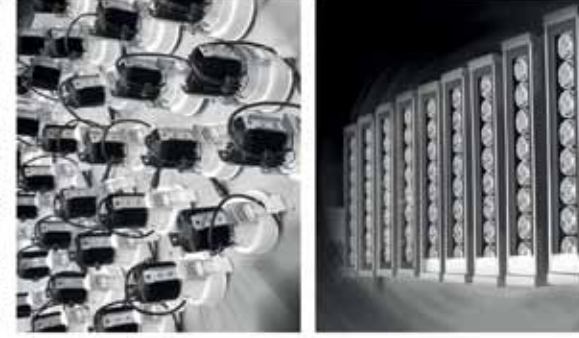
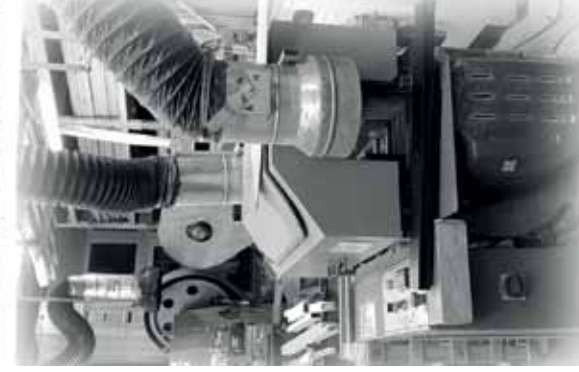
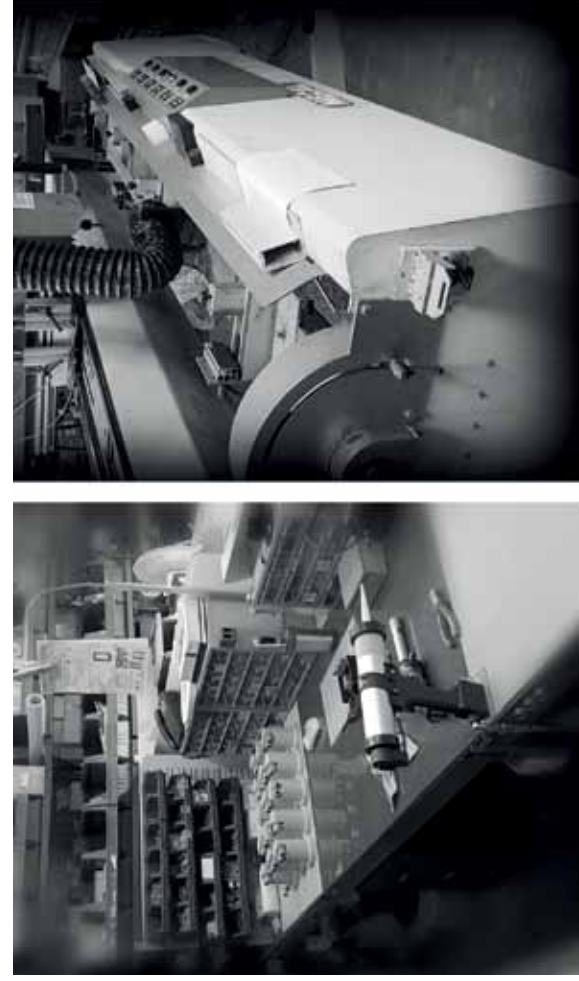

LUMINAIRES  
DESIGNED  
AND MADE  
IN GREECE  
SINCE 1973

## QUALITY TESTING LAB

Throughout the entire production process MPILLUMINATION distinguishes itself by handling the strictest quality parameters, to ensure products and services are designed and produced to exceed customer requirements.

Every step in the production process has a routine quality procedure, covering both product quality and testing. As such, each product that leaves MPILLUMINATION, has been inspected and tested thoroughly, resulting in maximum efficiency.

During the entire production our engineering team of professional technicians is fully committed to develop top quality fittings that comply with high efficiency rates, energy saving and long-lasting standards of life.

Our Lighting Laboratory is equipped to carry out performance measurements on all commercially available lamps and luminaires.

Our experienced engineers undertake performance tests using advanced equipment like testing machine for checking the electrical safety of our products in compliance with European standards by EN 60950, electronic oven for testing the thermal management of products, equipment for checking the quality of powder coating, as well as many other testing accessories.

Results are compiled in detailed test reports.

# LIGHTING STUDY

Every project starts with an idea. Our team collaborates closely with the client and design teams to develop strong concepts for lighting design. We study each project individually to determine lighting that will support project goals.

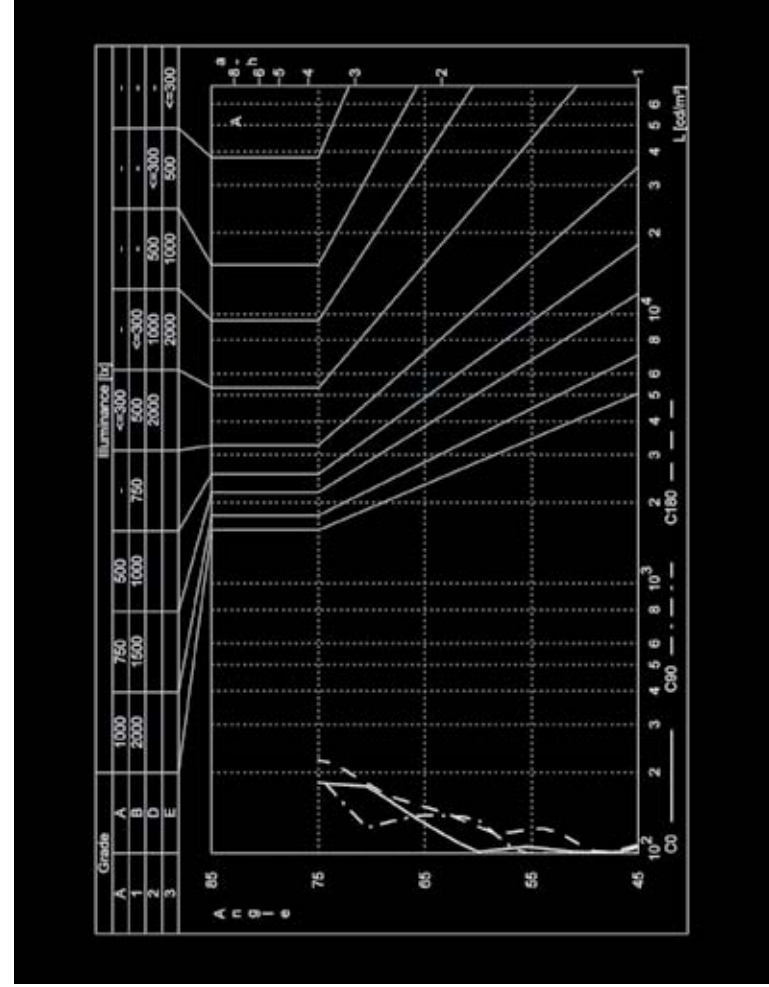
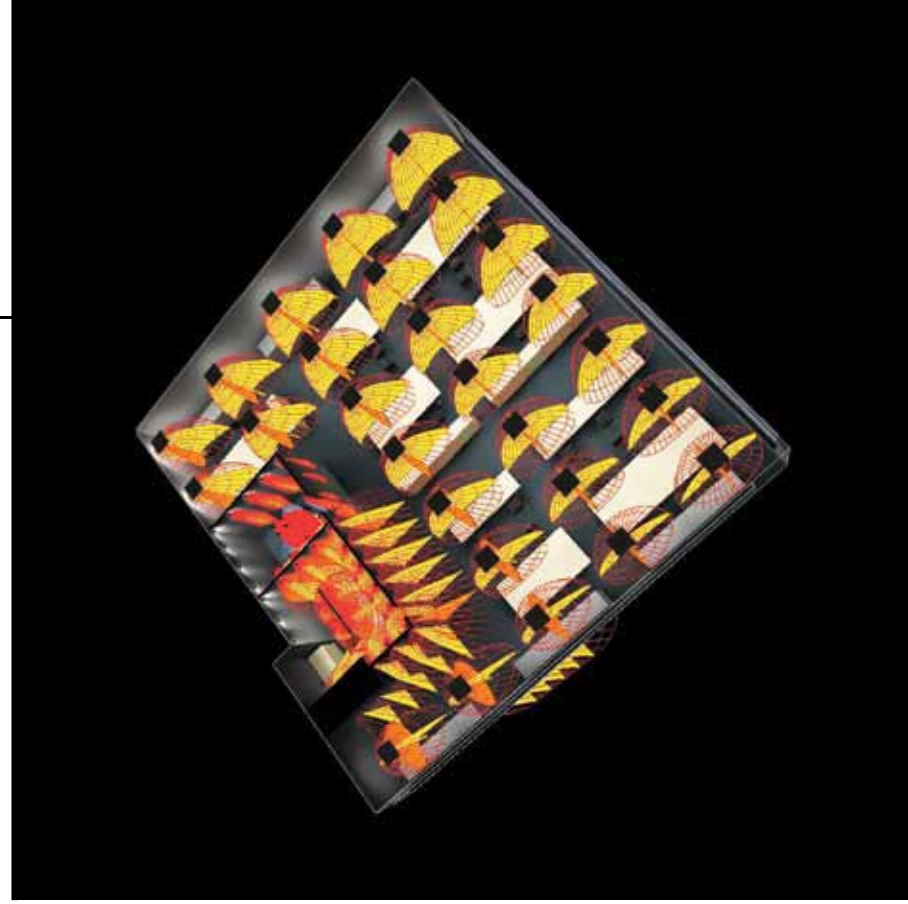
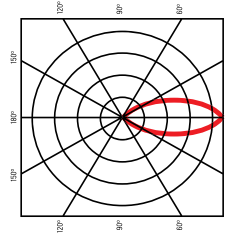

LIGHTING MEASUREMENTS INSTANTLY EVEN FOR SPECIAL CUSTOMIZED PRODUCTS

# DARK ROOM

MPILLUMINATION has recently upgraded its internal lighting lab, adding a great tool for light measurement of the company VISO SYSTEM in Denmark.

This new system allows us to measure the full 3D distribution field of any luminaire, and generate comprehensive LDT and IES simulation files.

As outsourcing of our photometric testing was time consuming and costly, working with external labs restricted our ability to make quick modifications.

After upgrading our internal testing facility we are much quicker and effective as:

- We already have a complete set of ldt files for our products and we can easily provide to our customers a complete, accurate and easy to understand test report for them.
- We have the ability to do small modifications measuring the effect of different solutions ( like different CCT, CRI, led chips, glass

finishes) and see photometric results of those changes instantly. That allows us extreme flexibility, especially when offering different versions of our luminaires in various projects, where both accuracy and rapidity are necessary.

- R/D is testing the effectiveness of different technical solutions and material, during production development, to find the best solution in terms of lighting efficacy. Our engineers are continually verifying optical designs and improving performances based on the result. In that way, we can now maximize the efficacy of our products.
- We can do lighting measurements even for special customized products.

This investment has helped us a lot develop and improve our product portfolio in a more accurate way, as we can double check straight away any measurement and provide information rapidly.

SINCE 1973

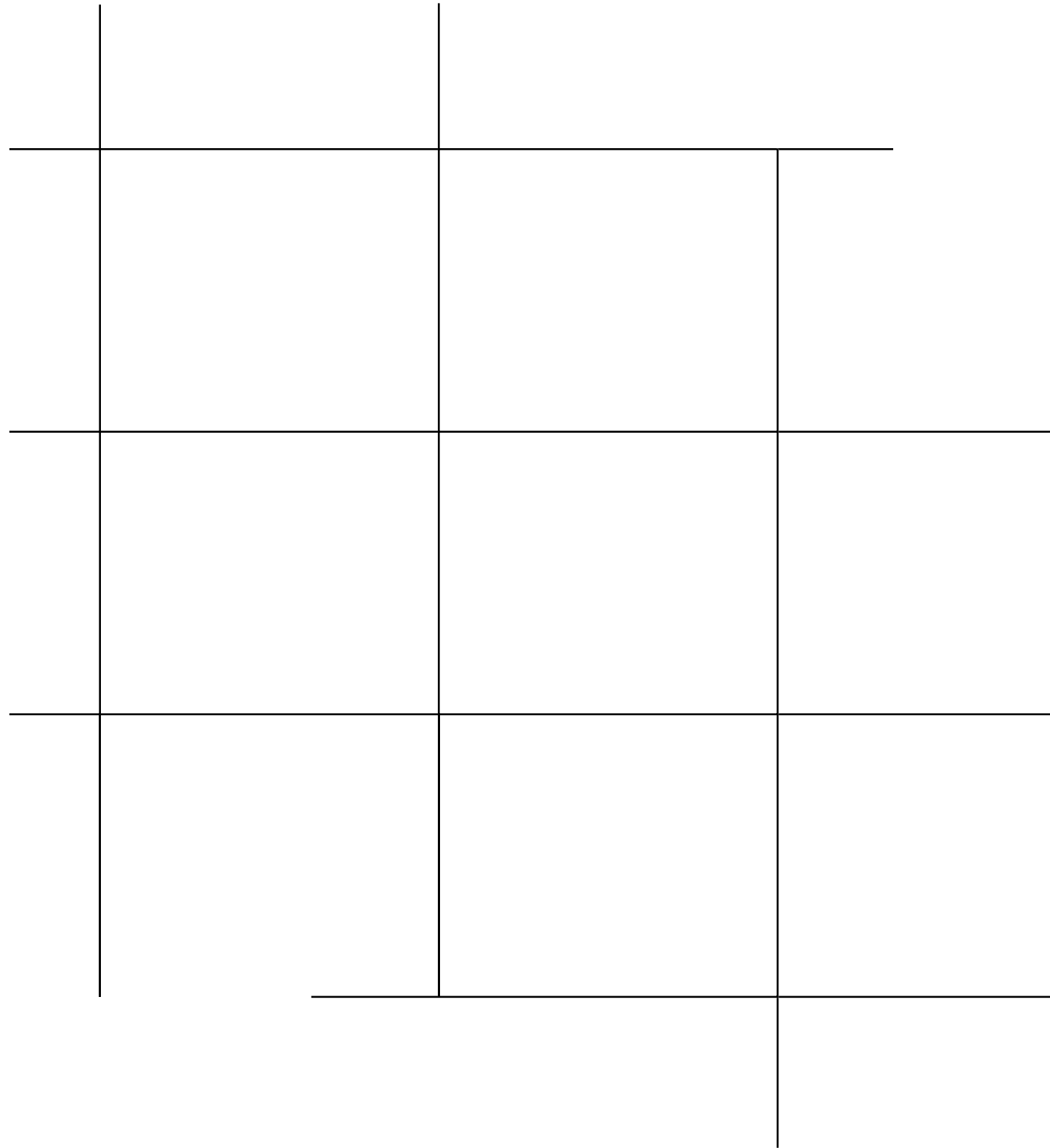

# OUR PRODUCTS

Our production line consists of more than fifteen categories that cover the complete range of indoor and outdoor luminaires, ideal for every demanding application, such as company offices, commercial centers, museums, airports, hospitals, public buildings, hotels, educational institutions, modern residences, public spaces, streets, ships, factories.



# FACADE LIGHTING



Technoline 10  
Compact

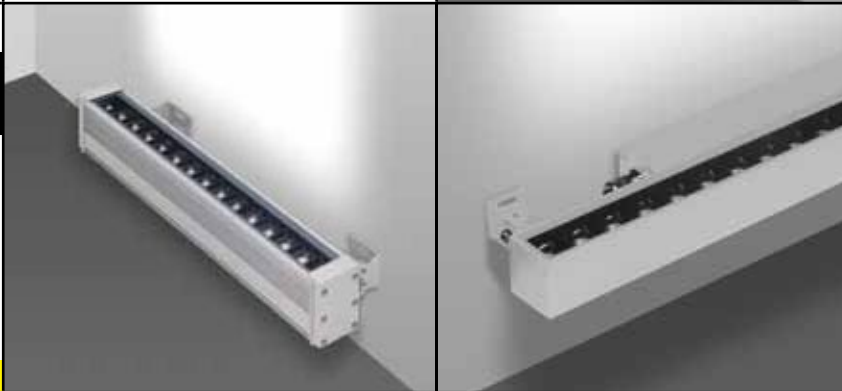

Technoline 9  
Slim High

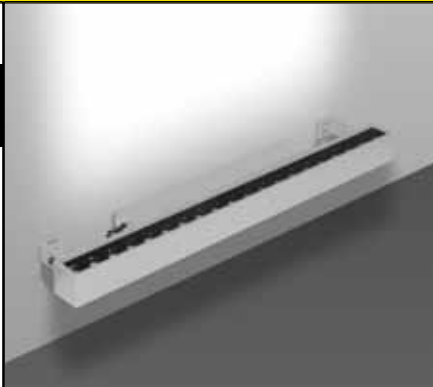

Technoline 11 LLE





# FACADE LIGHTING

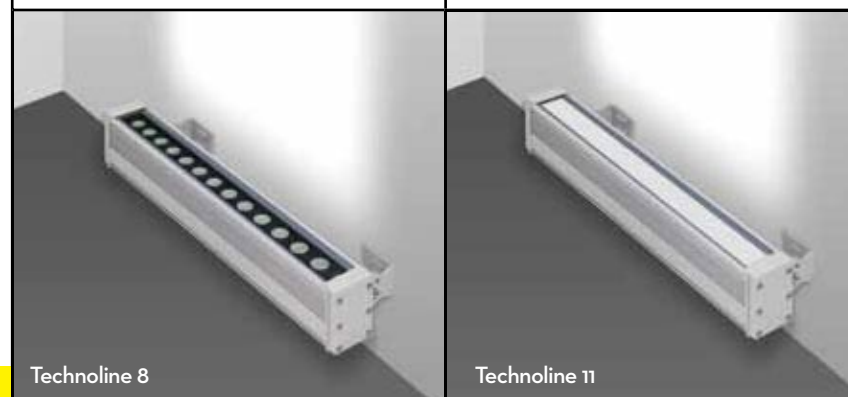

Technoline 8

Technoline 11



Technoline 7

Linear Light 5.1 Smd CC



Technoline 6

Technoline 60



Technoline 12 SMD



# FACADE LIGHTING

Technoline Mini 1



Technoline Mini 4



Linear Line Opal

2022



Hydroline Move Led 5 CV









Technoline Mini 2



Technoline Mini 2 opal



# CEILING MOUNTED

	 External Line 82 LLE	 Tube 120 CL Dark
	 Tube 148 REF	 Tube 148 CL Maxi
	 Slim Line CL Led	 Tube Ceiling Long HO

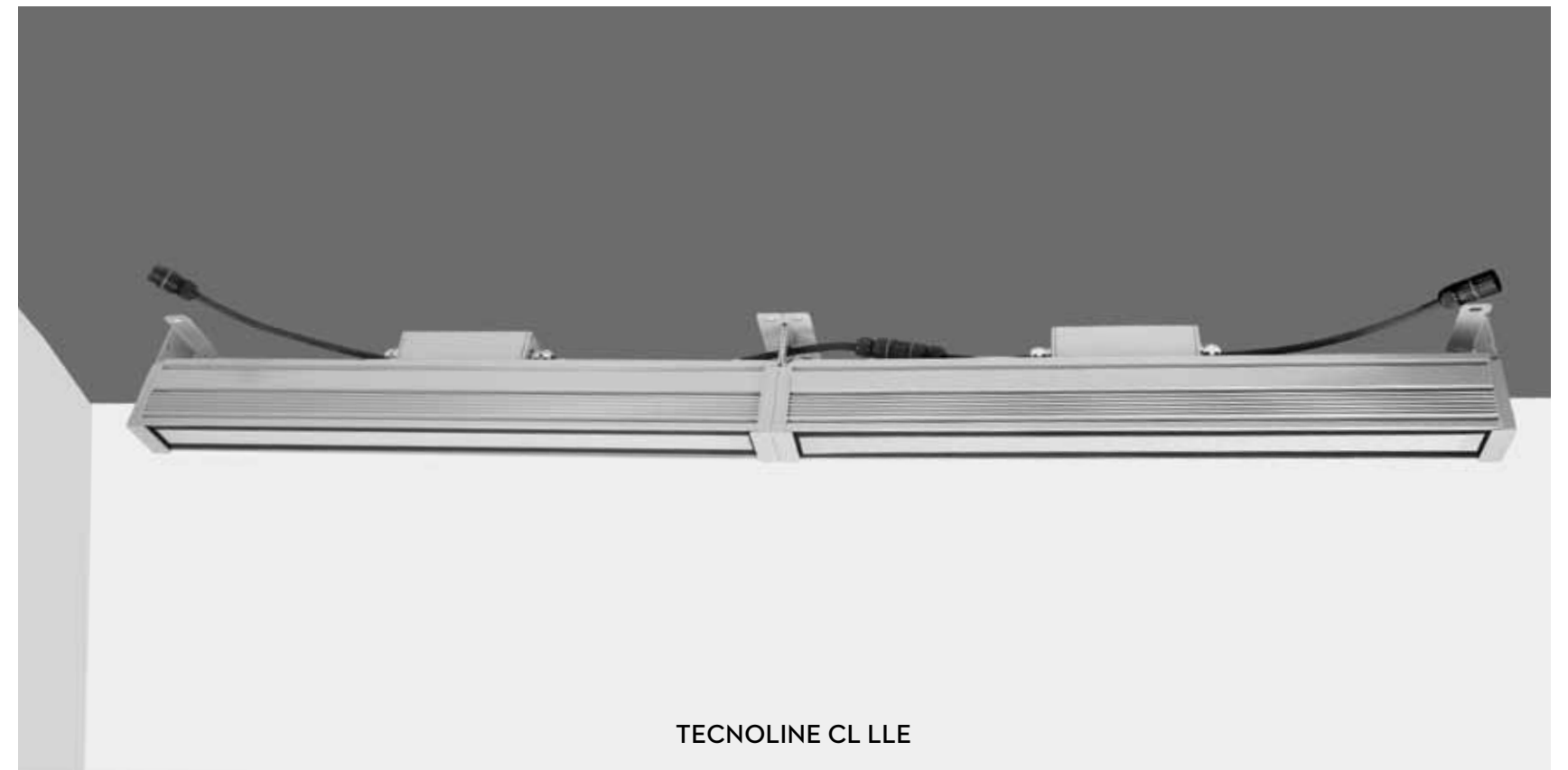
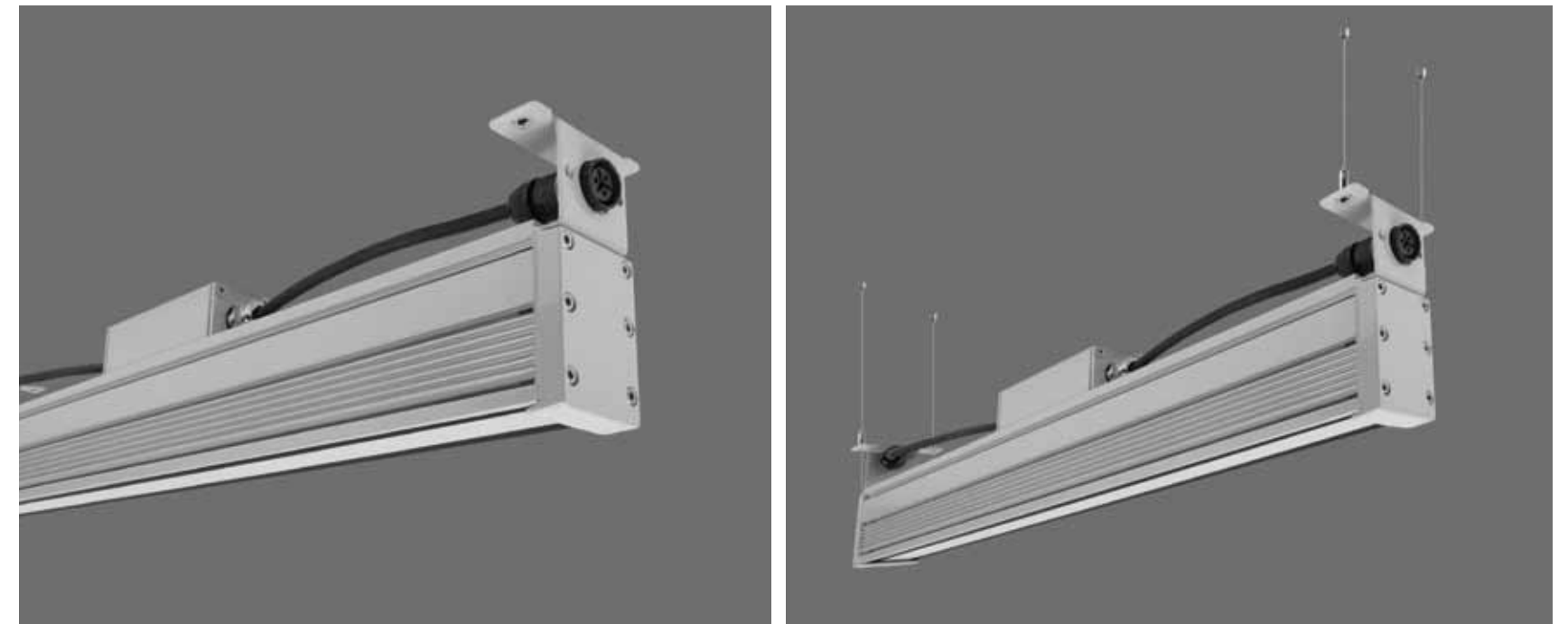

# CEILING MOUNTED



# INDOORS

CEILING  
MOUNTED



Tube 148 IN CL REF



Line 5 Dark CL



Spoty Square Deep



Line 10 Dark CL



Lip 120 Ceiling Fixed 1



Lip 82 NV1



Flexi CL 1



Spoty Darklight



# GROUND

SURFACE MOUNTED



Park indirect 1

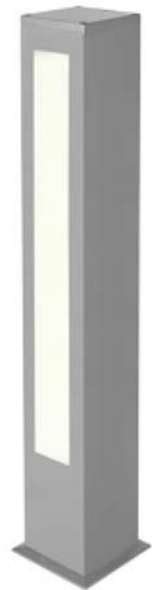

Cubic Garden TL



Park Indirect 3



Tower Line Led 1



Tube 106 Bollard 1L

2022

# GROUND RECESSED



Mini Faros RD 11 DC **2022**



Mini Faros SQ 10 DC **2022**

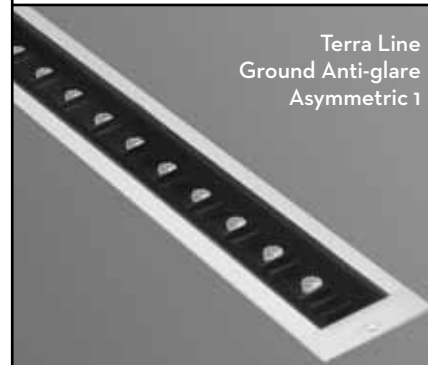

Terra Line  
Ground Anti-glare  
Asymmetric 1



Mini Faros 10 Back **2022**

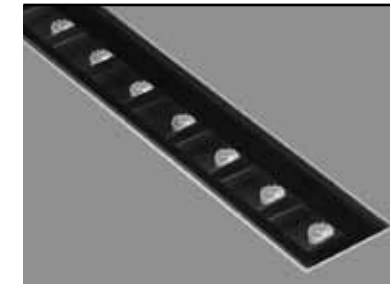

Terra Frameless **2022**

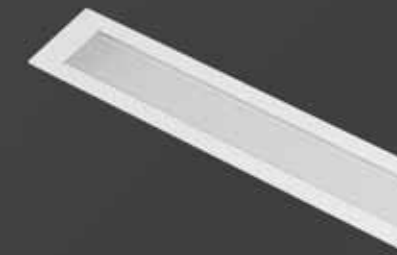

Slim Line Ground Opal



Mini Faros Brass



Mini Faros RD 10 DC **2022**

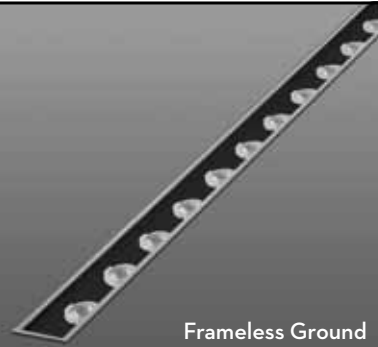

Frameless Ground  
Led 2 CV

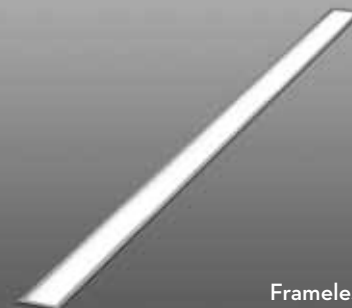

Frameless  
Ground Led 1



Terra Line Led 4 Inox



Matrix Inground 185



Mini Faros 50 1L



Matrix 185 Zoomable



Mini Faros



Terra Line Hide 6 **2022**



Mini Faros 6\_Ground

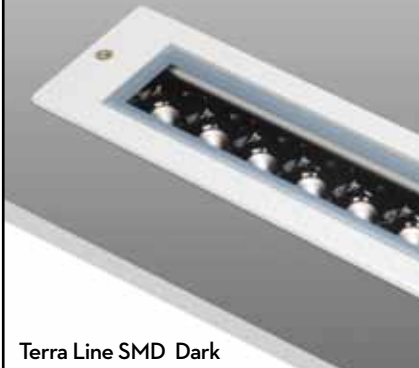

Terra Line SMD Dark



Matrix Inox Ground 4 Smd



Slim Line Ground Smd



Mini Faros 50 2L



Mini Faros 50 4L



Matrix Inground 125

# LINEAR

INDOORS  
LED LUMINAIRES

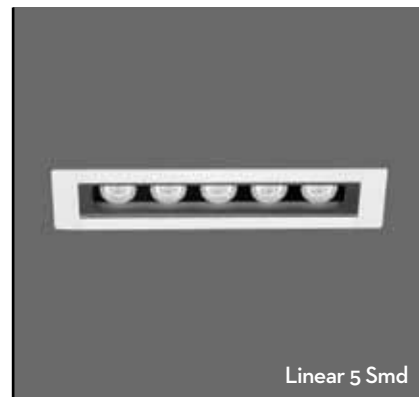

Linear 5 Smd

Linea In Line 5

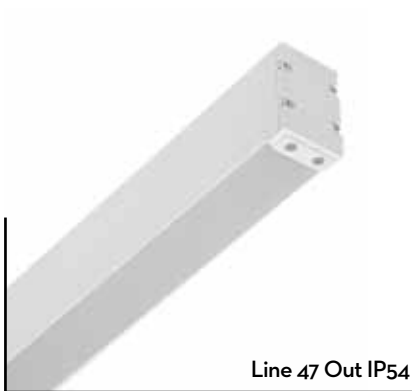

Line 47 Out IP54

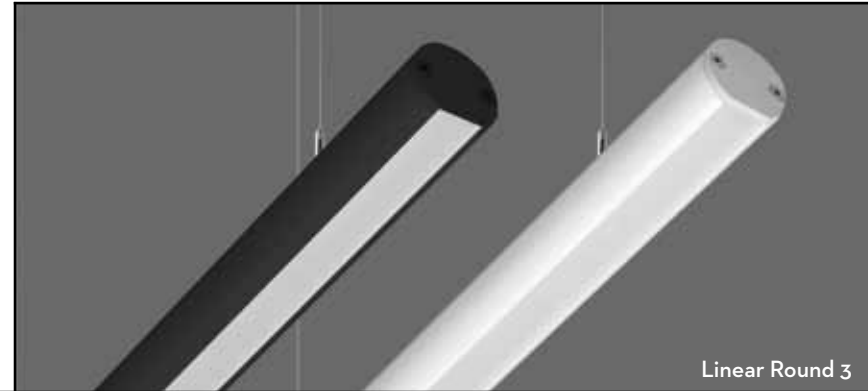

Linear Round 3



Line 69 IN IP54

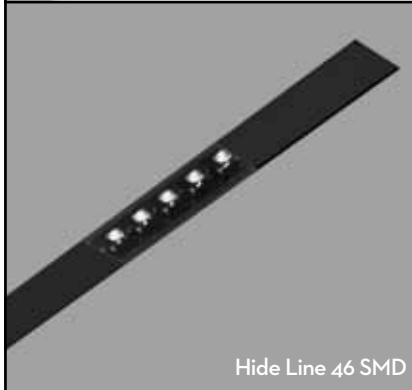

Hide Line 46 SMD

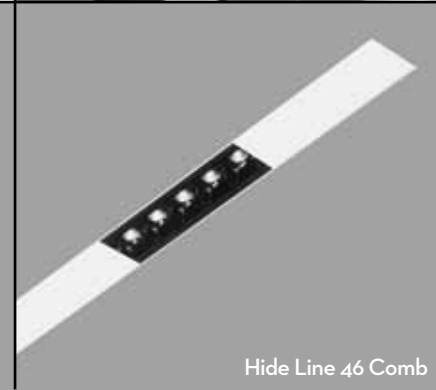

Hide Line 46 Comb



2022

Line 45 Trimeless with Spots 1



Tube 105 NV Mat



Line 46 SMD Dark



Slim LED Profile 12

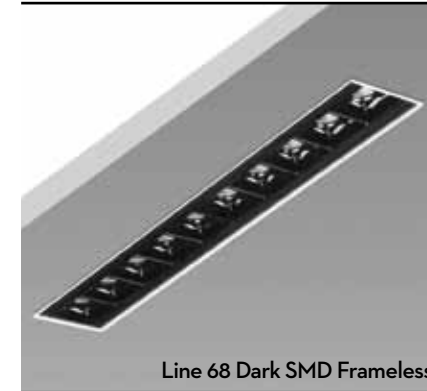

Line 68 Dark SMD Frameless



Line 31 SMD Dark 2

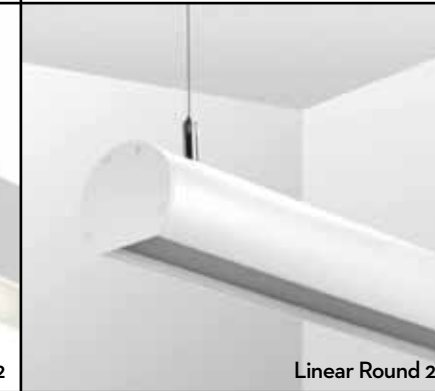

Linear Round 2

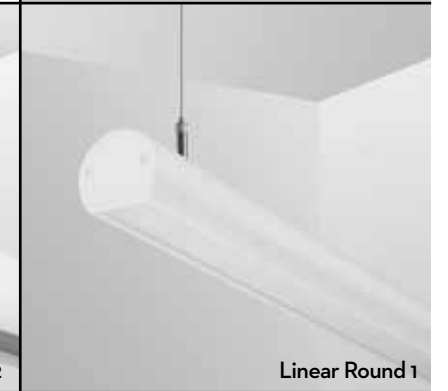

Linear Round 1

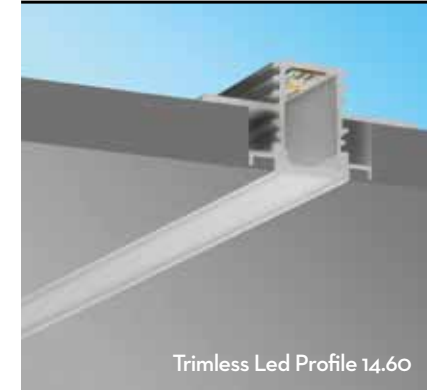

Trimless Led Profile 14.60

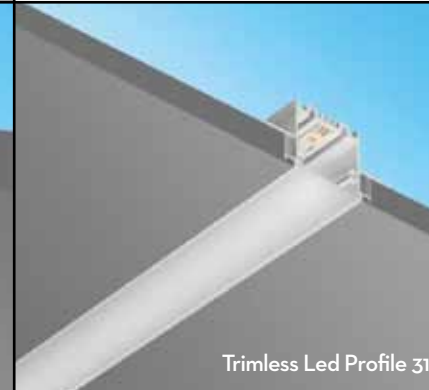

Trimless Led Profile 31

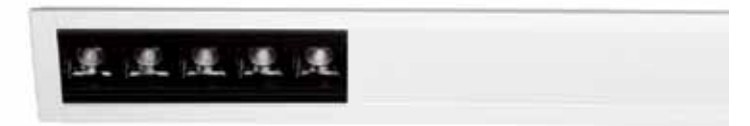

Line 68 SMD Dark 2



# WATERPROOF PROJECTORS



Tube 75 Bs Focus



Tube 75 BSG 2



Tube 120 BS

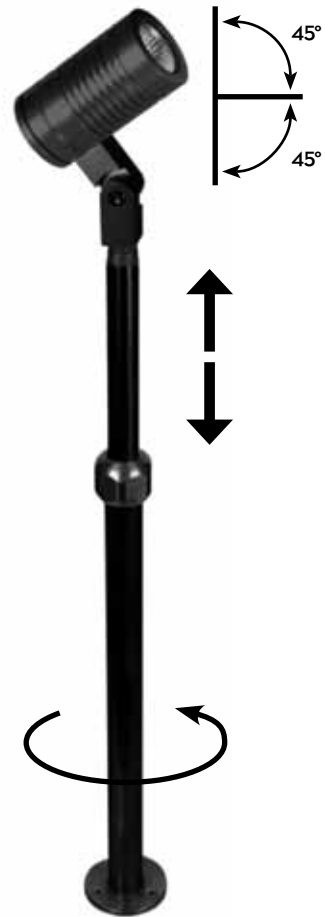

Mini Faros 50 ADJ Pole

2022



Prestige 60 PRG



Prestige 60 PR



Tube 75 BS 2



Tube 75 BS 2



# WATERPROOF PROJECTORS

Tube Energy 50 ALU



Tube 106 SMD Spike

2022



Cubic Energy 12 Led



Cubic Focus 16 Extra Narrow



Matrix PR Extra Narrow



Tube Energy 60 Base



Tube Energy 60 Base



Tube Energy 50 BRASS



Cubic 85 PR 2



Tube Energy 75 AC



Tube 106 CI Spike

2022



Tube 148 Cob LedV4



TUBE 120 COB LED 2



TUBE 120 G COB LED 2

# TRACK SPOTLIGHTS



Tube 100TR | Tube 75 TR | Tube 50 TR

2022



Tube 100 On Track



Tube 82 TR 20 BL



Flexi 40 TR



Tube 116 On Track



Tube 84 TR 4



Tube 84 TR 1



Tube 125 AC LED TR



Dark Track 2



Tube 84 TR 5

2022



Dark Track 1



Tube 82 TR 21



Flexi 54 TR



Flexi 60 TR

2022



Conico Track 1

2022



Tube 84 TR 3

# RECESSED SPOTS



Lip RD 114 Dark Rotate

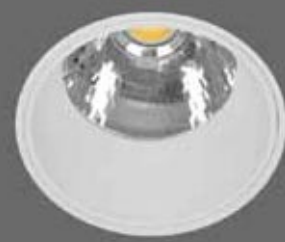

Trim 62 FD WH



Gemini UGR Mat



Multiline 157 Move 2



Gemini PIN SQ 90



Multiline 120 FD 2



Lip RD 114 MV Tube



Frameless Double Move Focus 1



Lip 114 RD FD



Frameless Deep 3

Frameless Square  
Deep Move Cob  
Led Black Internal



Lip SQ 114 Dark Rotate



Multiline 120



Orion 55 RD B



Mini Tube Directional SQ 1



Frameless Round Move Focus 1



Frameless SQ Rotate DP Led



Lip SQ 114 MV Tube



Gemini Sq Ugr Mat



Lip SQ 114 Fixed 2



Frameless SQ Rotate DP Led

# RECESSED SPOTS



Astra 118 Darklight 2



Gemini 85 Rotate



Lip RD 83



Mini Lip 46



Gemini 100 Rotate



Frameless Round Rotate DP Led



Gemini FD 84



Comfort Dark CL



Gemini SQ 52



Comfort Dark SQ CL 120



Lip 110 Nova Mat



Gemini 120 Dark Rotate



Lip 114 T



Gemini Pico 40



Gemini 100 Pin 1



Recessed



Gemini Move 60



Trim 62 FD BL



Trimless MV 72



Gemini 100 Pin 2



Gemini 120 Dark FD

# WALL SURFACE MOUNTED 2021



Elegance Nova Asymmetric External 2 Led



Quattro Darklight 5 Led



Luce Dark Wall EXT



Tube 148 REF Wall



Tube 120 AC Led 2



# WALL LUMINAIRES



Linea Concept 2

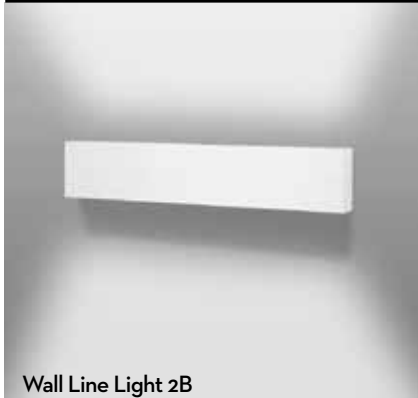

Wall Line Light 2B



Wall Line Light 1B



Step Led Asymmetric Mini

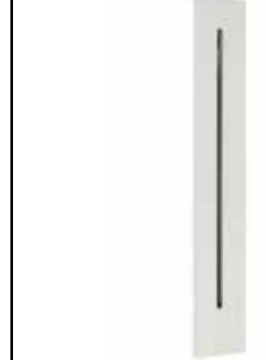

Step LED Maxi Line

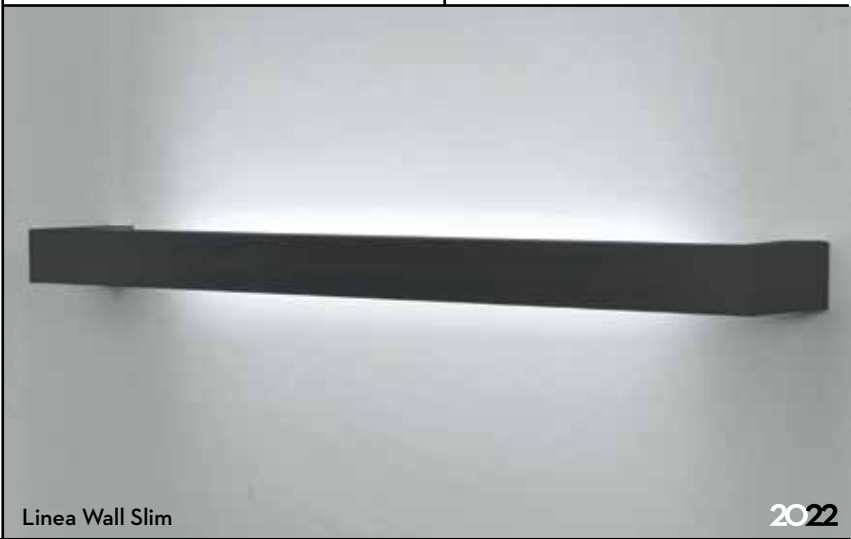

2022

Linea Wall Slim

2022



Led Profile Move 2 CC



Slim Wall Line SQ



# WALL FIXED LED LUMINAIRES

2022 Cubic Led Lens 2L

Cubic Led Lens 4L

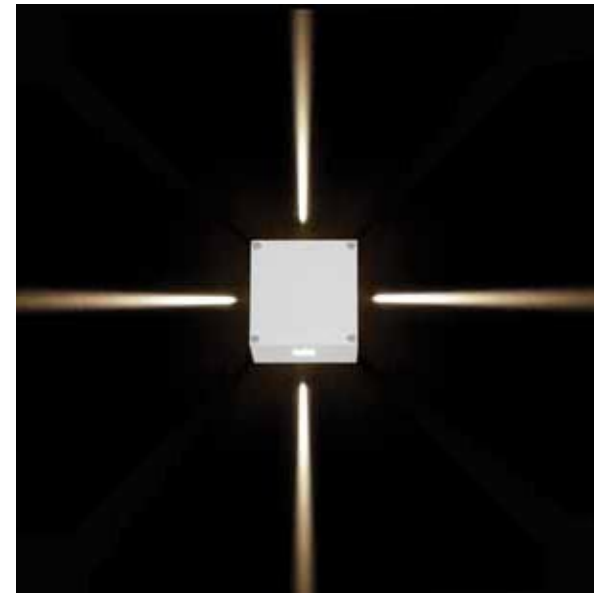

External Line 1 LLE Single



Tube Wall 105 2L Led



External Line 2 Smd Led



External Line 2 Smd Led Single



Tube 120 NV Wall 1L



Tube 75 W1 CL



Linear Angle MD



Cubic Wall

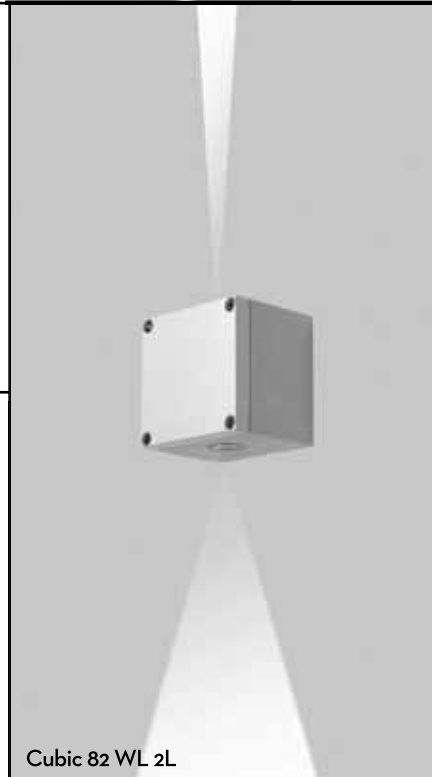

Cubic 82 WL 2L

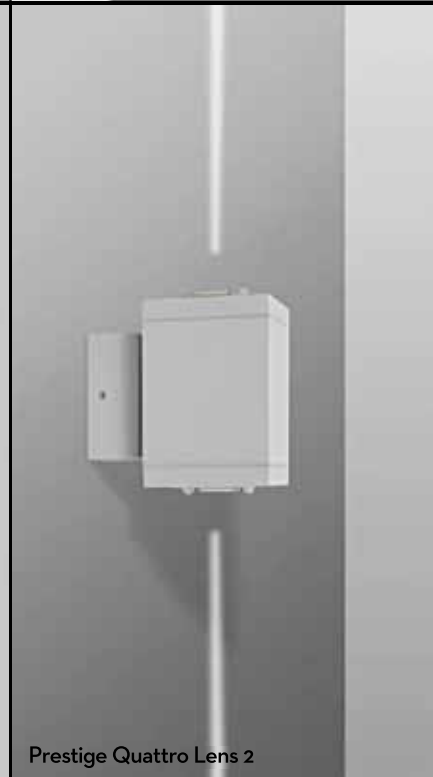

Prestige Quattro Lens 2



Tube 75 W2 CL



Prestige Quattro Lens 1



Tube 106 Cl Wall



Cubic 11 Smd Up Sown Short



# WALL RECESSED

		 Luce 7 Sym Slim	
	 Luce 6 Picco Directional Led	 Quattro 3 Maxi Asymmetric Brass Led	
 Quattro Darklight 5 Recessed Led	 Elegance 2 Asymmetric Inox Led	 Luce 6 Asym Slim	
 Luce 1 Lux Asymmetric Inox Led	 Quattro Darklight Brass Led	 Quattro Darklight Led	 Faretti Directional

 Luce Line 45	 Luce 65 SYM	 Luce Darklight 2
 Luce Line 45	 Luce Maxi Directional Linear LED	 Elegance Asymmetric 1-2 Nova
 Luce Darklight 65	 Mini Faros 7 Led	 Mini Faros 8 Led

# QUALITY OF LIGHT PERFORMANCE

In MP ILLUMINATION we use high-power LEDs and Chip-on-Board LED (COB). The high quality of LEDs supplied with luminaires combined with the highest efficiency lens, reflectors & optical systems provide the greatest distribution variety.

## LED SPECTRUM

MP ILLUMINATION luminaires provide options from neutral white (4000K) warm white (3000K) and extra warm (W27, 2700K). Some fixtures can be offered in tunable-white (2700K to 6500K) or RGBW (Red, Green, Blue, White) colour-changing sources upon request.

## LED COLOUR RENDERING

The colour rendering index (CRI or Ra) is a standard metric to describe a light source's ability to accurately reproduce color. Generally, for LED fixtures, a colour rendering index between 80 and 90 is considered as

good and a value between 90 and 100 is considered as excellent. MPILLUMINATION provides fixtures with a tested CRI value >80 for general indoor and outdoor as standard, however, CRI >90 is optional upon request.

## LED COLOUR DEVIATION

MP ILLUMINATION uses high-power LEDs and Chip-on-Board LED (COB) with 3 SDCM (or 3-Step MacAdam ellipses) as standard for most indoor and outdoor project applications.

## LED LUMEN MAINTENANCE

The lumen maintenance average rate performance of MP ILLUMINATION LEDs is over 90% after 50,000 hours. We mostly use LEDs with the specification of L80/B10 at 50,000 hours, this means that after 50,000 hours, at least 90% of the LEDs still achieve 80% of their original luminous flux.



# ECOLOGICAL CONSCIENCE

MP ILLUMINATION promotes its ecological conscience and invests in energy saving technologies.

MP is shareholder of FOTOKYKLOSI S.A., a recycling company for lighting fittings and lamps approved by the MINISTRY of ENVIRONMENT & ENERGY in Greece.

Our prime principle is to design and develop lighting fixtures of high quality standards that incorporate energy saving lamps and latest LED technologies, aiming towards reduction of power consumption and promotion of environmental protection.

# HIGH ENDS PRODUCTS

Our luminaires are manufactured with the goal of lasting over time and ensuring constant performances.

We use high quality aluminum alloys, as well as brass and stainless steel materials , to make sure that our products resist harsh environmental conditions.

All fixtures are finished using our superior powder coating process, with possibility of "seaside" powder coating as an option where desired for extreme environments.

We select only the highest grade of components and we design their integration within our luminaires using our many years of experience and technical expertise.

We are continuously improving previous and evolving new ranges, with new inspirations, as well as with a wide range of finishes.

We verify heatsink designs to ensure maximum life duration of cob led and minimum lumen depreciation for all our products.



# RECENT INTERIORS PROJECTS

HELLENIC BANK - CYPRUS

AIN DUBAI TERMINAL - UAE

PUBLIC INSTITUTE OF ADMINISTRATION - OMAN

TAWILA ISLAND - EGYPT

AL GURUM RESIDENCES ABU DHABI- UAE

RUSSIAN ORTHODOX CHURCH- CYPRUS

AL ALAMEIN HOTEL- EGYPT

SOHAR HOSPITAL EXPANSION- OMAN

NGU ENGINEERING BUILDING - EGYPT

NIZWA HOSPITAL - OMAN

CITY OF DREAMS CASINO RESORT- CYPRUS

SEAT SHOWROOM - SLOVAKIA

MEDITERRANEAN BEACH HOTEL - CYPRUS

LONGINES WATCHES STORE - KINGDOM MALL  
- SAUDI ARABIA

ENOC - EMIRATES NATIONAL  
OIL CO. OFFICES - UAE

MADINITY MALL - EGYPT

BANK MISR- EGYPT

HOSPITAL SACA- SLOVAKIA

URBAN TESCO MALL - SLOVAKIA

ABU DHABI AIRPORT - UAE

LARNACA AIRPORT - CYPRUS

SKYCOURT BUDAPEST AIRPORT - HUNGARY

SORBONNE UNIVERSITY - UAE

AL BARRARI RESIDENCES - UAE

AL JIMMI MALL - UAE

PRIVATE VILLAS - SEYCHELLES

PARK HYATT HOTEL - UAE

FIRST GULF BANK - UAE

RUWAI PALACE - UAE

AL RAHA BEACH DEVELOPMENT - UAE

ZAYED UNIVERSITY - UAE

AL RAWDHA PALACE - UAE

BATEEN SCHOOL - UAE

FUTURE SCHOOLS - UAE

FOODCOURT ATHENS AIRPORT - GREECE

DUSIT HOTEL - UAE

KHALIFA PORT - UAE

EMIRATES PARK TOWER HOTEL - UAE

BATEEN PALACE - UAE

AQABA PROJECT - JORDAN

KING ABDULLAH PARK - JORDAN

AL AIN SCHOOLS - UAE

RITZ CARLTON HOTEL - EGYPT

6TH OF OCTOBER PROJECT - EGYPT

CITY STARTS PROJECT - EGYPT

HILTON HOTEL DEAD SEA- JORDAN

SAMA BEIRUT TOWER- LEBANON

INTERCONTINENTAL HOTEL - FIJI ISLANDS

M-PRESS COMMERCIAL COMPLEX - KUWAIT

TIRES RECYCLING FACTORY - KUWAIT

SHARJAH LABOR OFFICE - UAE

SABB HEADQUARTERS - SAUDI ARABIA

YAS SOUTH DEVELOPMENT INFRASTRUCTURE - UAE

PASTEUR LOBBIES - LEBANON

M-Z ALAMEIN - EGYPT

PRIMARY SCHOOL OF AGION ANARGIRON- CYPRUS

BLF BANK GHAZIR - LEBANON

CYB BANK HEADQUARTERS - EGYPT

BILLBERRY WATERFORD - ENGLAND

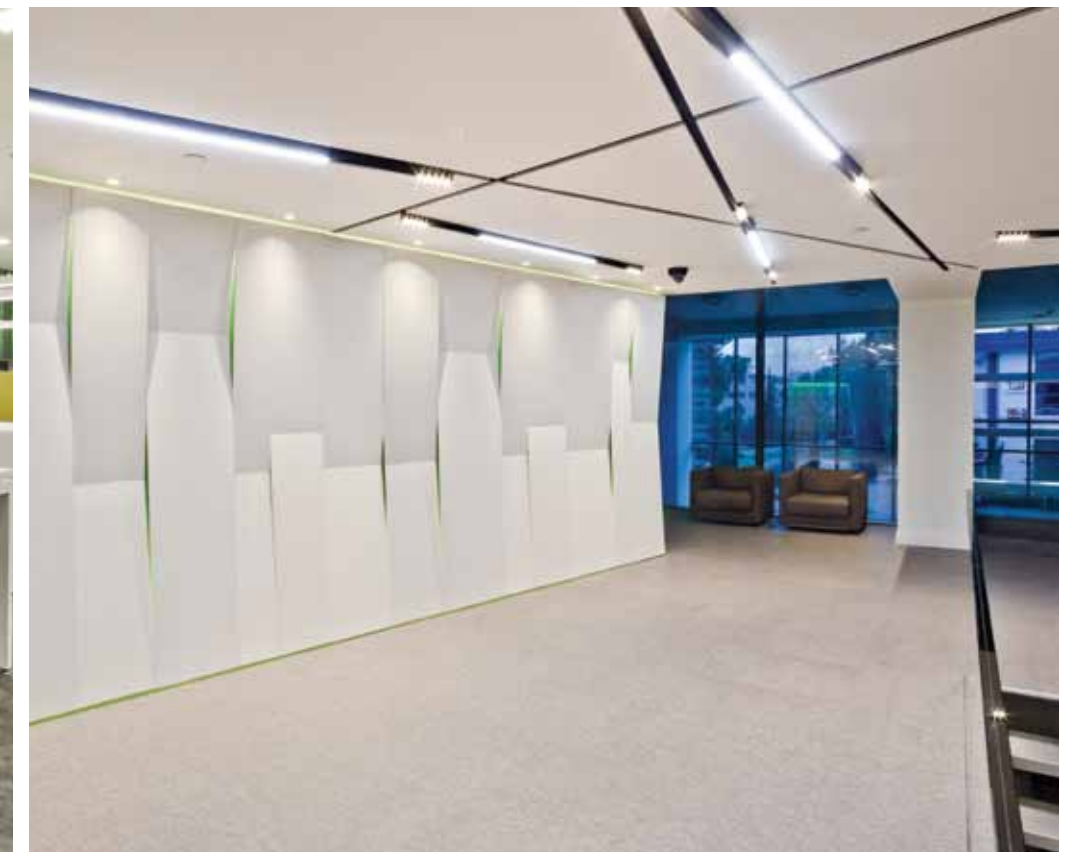

# GLOBAL PRESENCE & EXPORTS

MP ILLUMINATION is continuously expanding its global presence and is ready to provide its customers with excellent service and collaboration to provide the best solutions. With a presence in more 40 countries, all over the world, MP is definitely a very credible and competitive partner for all your projects.

Our dedication to service and technical support guarantees that every customer will get personalized attention and service at any stage of a project, as well as constant technical support.

## OUR GLOBAL NETWORK

MPILLUMINATION has developed a well organized network all over Greece and internationally, expanding its export activities in the following countries:

- Cyprus
- Ireland
- Belgium
- Netherlands
- England
- Hungary
- Lithuania
- Slovakia
- Estonia
- Montenegro
- Russia
- USA
- Slovenia
- India
- Poland
- United Arab
- Serbia
- Emirates
- Croatia
- Saudi Arabia
- Romania
- Qatar
- Belgium
- Lebanon
- Denmark
- Egypt
- Czech Republic
- Jordan
- Norway
- Israel
- Finland
- Bahrain
- Portugal
- Kuwait
- Malta
- Oman
- Austria
- Turkey
- Bulgaria
- New Zealand
- Albania
- Nigeria
- France
- Marocco
- Switzerland
- Algeria



# RECENT INTERIORS PROJECTS

UAE EMBASSY - LEBANON

CITY FITNESS GYM - MONTENEGRO

ORA FOURTEN LUXURIOUS RESIDENCES-  
MONTENEGRO

HOTEL BUDVA - MONTENEGRO

FALKENSTAINER HOTEL - MONTENEGRO

QORTUBA OASIS - SAUDI ARABIA

KING ABDULLAH FOUNDATION - SAUDI ARABIA

FAIRMONT HOTEL - SAUDI ARABIA

HASHEMITE UNIVERSITY- JORDAN

RADISSON BLU HOTEL - SAUDI ARABIA

AL FAAISALIAH HOTELS - SAUDI ARABIA

PRINCESS REEMA VILLA - SAUDI ARABIA

GOLF CLUB HOUSE - SAUDI ARABIA

EAST GATE PARK OFFICES - SAUDI ARABIA

SEC HEADQUARTERS OFFICES - SAUDI ARABIA

PALM MALL SOHAR -OMAN

KALEV SPA - ESTONIA

GRAND MOSQUE - ALGERIA

SATELLITE CASINO- SINGAPORE

OASIS ALILAH SALAHA RESORT -OMAN

THE BEACH COMPOUND- EGYPT

PALM MALL MABELAH -OMAN

CLEMENCEAU MEDICAL CENTER- UAE

MULBERRY PARK HEIGHTS - UAE

RAMLA TOWER - SAUDI ARABIA

WATER GARDENS -ENGLAND

LANITEIO GYMNASIUM - CYPRUS

AL FARDAN MIXED RESIDENCES- OMAN

AL AIRAMI BOULEBARD MALL -OMAN

ROP STABLE COMPLEX -OMAN

AL GHURAIR RESIDENCES - UAE

LEBANESE UNIVERSITY - LEBANON

AL MANSOURA - EGYPT

CAMDEN FOODS RAILWAY STATION - ENGLAND

HYUNDAI CAR SHOWROOM - HUNGARY

GEMMAYEZ APARTMENTS - LEBANON

METRO RIYADH - SAUDI ARABIA

MUBARRAK COMMERCIAL BUILDING - UAE

GOLDEN TOWER - ISRAEL

BUDAPEST AIRPORT - HUNGARY

JAPANESE UNIVERSITY - EGYPT

KUWAIT MOTOR TOWN - KUWAIT

AGRICULTURAL BANK - EGYPT

AIN FADYA SCHOOLS - UAE

SHARJAH SCHOOLS - UAE

ACACIA AT PARK HEIGHTS - UAE

FONTANA HOTEL - MONTENEGRO

REZIDENT PLACE - MONTENEGRO

HOTEL WOOW PLACE - BUDVA MONTENEGRO

LUSTICA BAY (4 VILLAS) - MONTENEGRO

WEST BAY BANK-MONTENEGRO

HAJRI HOTEL - UAE

FOUR SEASONS NILE PLAZA- EGYPT

FOUKA BAY -EGYPT

FHADILI RESIDENCES ARAMCO - SAUDI ARABIA

SHEIKH ZAYED BIN SULTAN ROAD -UAE

AL AIN PARKS -UAE

AURA HIGHLAND APARTMENTS -EGYPT

GARAGE ENGHAM -ENGLAND

CHELTENHAM COLLEGE -OMAN



## FACTORY

Pentagion & Tritonos Str.  
Skaramangas 12462 | Athens | Greece

## FACTORY SHOWROOM

8, Palaska Str.  
Skaramangas 12462 | Athens | Greece

T. +30 210 5577445 | +30 210 5570430

F. +30 210 5579878

info@mpillumination.com

export@mpillumination

WWW.MPILLUMINATION.COM