













Step Led 37 SQ B



- Χωνευτό φωτιστικό τοίχου
 - στεγανό
 - αλουμινίου
 - ηλεκτροστατικά βαμμένο με πολυεστερική πούδρα
 - κατάλληλο για ασύμμετρο darklight φωτισμό
 - κατάλληλο για χωνευτή τοποθέτηση σε τοίχο από γυψοσανίδα
 - ή σε τοίχο από μπετό με συνοδευτική βάση
 - με ενσωματωμένο High Power Led τεχνολογίας SMD
 - με ενσωματωμένη ψήκτρα υψηλής απόδοσης
 - για την καλύτερη διαχείριση θερμότητας του led
 - σε θερμοκρασίας χρώματος 3000 Kelvin
 - κατόπιν παραγγελίας και σε 2700-4000 Kelvin
 - CRI>90
 - λειτουργεί με εξωτερικό led driver
 - κατάλληλο για φωτισμό διαδρόμων, σκαλοπατιών
 - κατάλληλο για εσωτερικούς και εξωτερικούς χώρους
-
- Recessed step led
 - from die cast aluminum
 - polyester powder coated
 - suitable for asymmetric dark light effect
 - suitable for placement onto wall
 - made from plaster, with 2 side springs
 - or onto concrete wall by using a supporting wall base
 - with incorporated POWER LED SMD technology
 - with high performance heatsink
 - for best heat management
 - in 3000 Kevlin
 - upon request in 2700-4000 Kevlin
 - CRI>90
 - Works with remote/external led driver
 - suitable for lighting corridors and walk steps
 - suitable for interior and exterior use

CRI>90 | Led source power and Luminous flux

System power depends on the selection of the led driver

| | | | | | |
|--------------|---|----------------------|--------------------------------------|---|---|
| 37363 |  | 1.2W 350ma | 3000 KELVIN 27 LUMEN |  |  |
| 37364 |  | 1.8W 500ma | 3000 KELVIN 38 LUMEN |  |  |
| 37365 |  | 2.2W 700ma | 3000 KELVIN 54 LUMEN |  |  |
| 37366 |  | 1.8W 24V DC | 3000 KELVIN 25 LUMEN |  |  |

 37 x 37mm

 32 mm

CE 

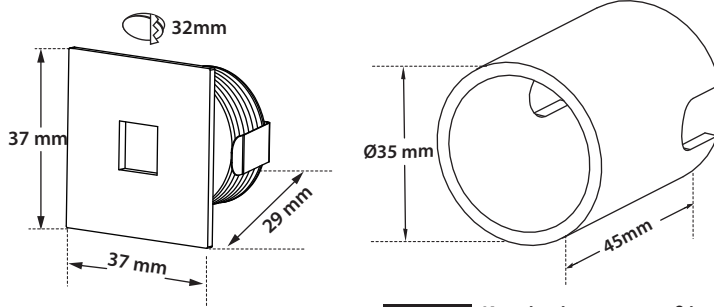

5380 Κουτί επίτοιχης τοποθέτηση
Box for wll recessed wall

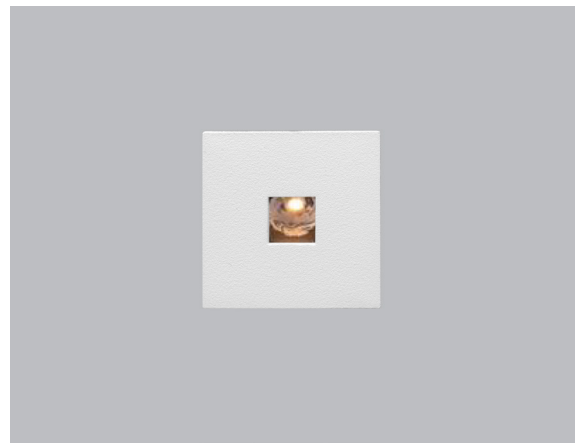
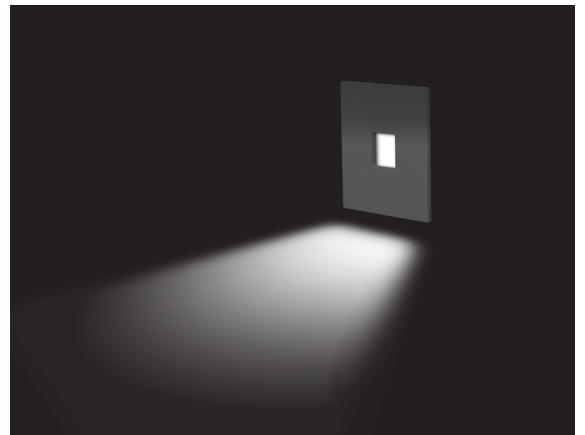
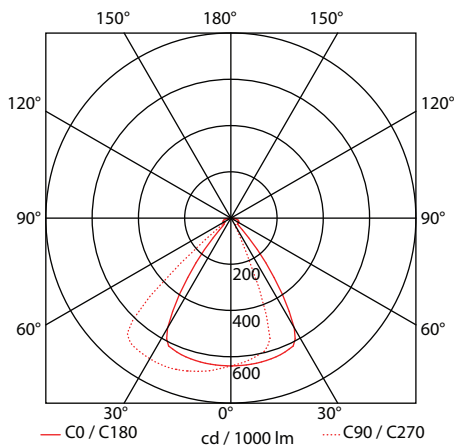

01 Standard Βαμμένα με Πολυεστερική Ηλεκτροστατική Βαφή
Painted with Polyester Electrostatic Powder

02 **05** **18** Upon Request

i *Η τεχνολογία των LED είναι σε διαρκή εξέλιξη οπότε πριν παραγγείλετε, παρακαλούμε επιβεβαιώστε ποιο LED είναι διαθέσιμο
LED technology changes constantly forward, so before selecting / ordering the most suitable product for you,
ask for a confirmation that this is the most updated product to our list.

■ warm 2700 Kelvin ■ warm white 3000 Kelvin ■ neutral white 4000 Kelvin