

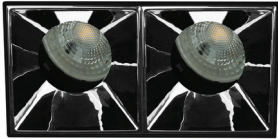

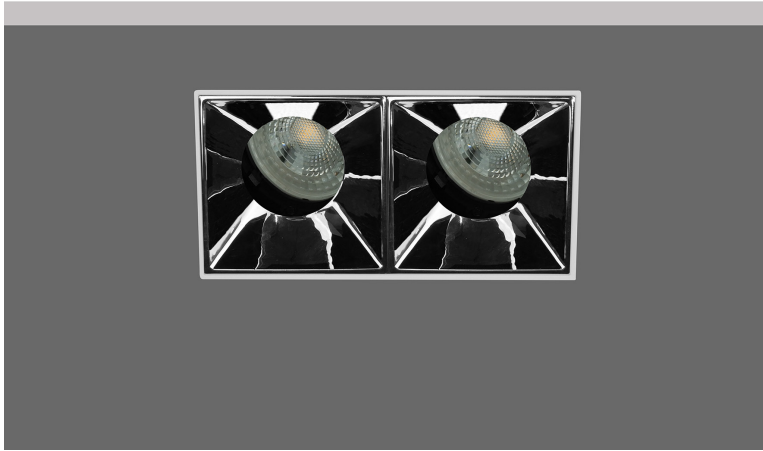



# Hide Double SQ 72 MV Chrome RF

Retrofit Version



- Διπλό σποτ χωνευτό σε γυψοσανίδα
  - εσωτερικού χώρου
  - χυτό αλουμινίου
  - χωρίς εξωτερικό στεφάνι
  - trimless/frameless
  - με την πηγή φωτισμού τοποθετημένη
  - βαθιά στο εσωτερικό
  - για μείωση της θάμβωσης
  - περιστροφικό
  - κινητό οριζοντίως  $\pm 355^\circ$  και καθέτως  $\pm 30^\circ$
  - κατάλληλο για λυχνίες τύπου MR16
  - 12volt GU5.3 ή 220-240volt GU10
- 
- Recessed false ceiling double spotlight
  - suitable for indoors use
  - from die cast aluminum
  - trimless/frameless
  - lighting source is positioned
  - deep inside the body of the spot
  - for reduce of glare
  - tiltable
  - movable horizontally  $\pm 355^\circ$  and vertically  $\pm 30^\circ$
  - suitable for lamps type MR16
  - 12volt GU5.3 or 220-240volt GU10

<b>42046</b>	<b>MR16 DICHOIC 220-240V   2x50W GU10</b> <b>MR16 LED LAMP GU10   220-240V 2x12W MAX</b>	
<b>42047</b>	<b>MR16 DICHOIC 12V   2x50W GU5.3</b> <b>MR16 LED LAMP 12V   2x12W MAX GU5.3</b>	
 144x72 mm  145x75 mm  104 mm                    CE 		

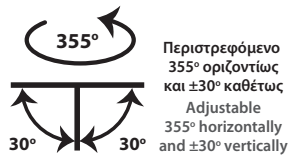
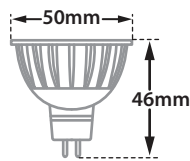
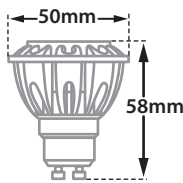
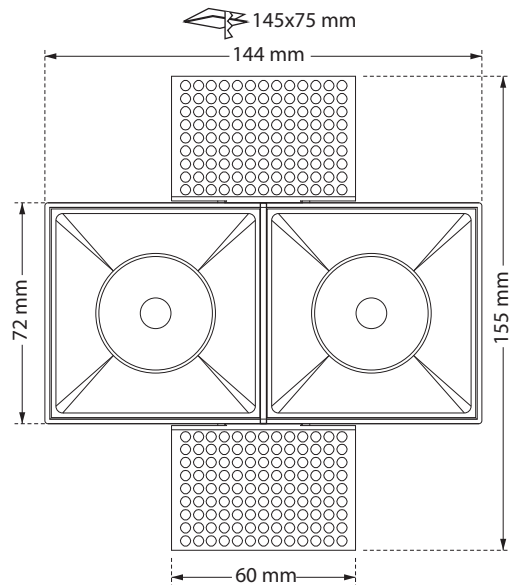

**Accessories upon request**



Honey comb  
louvre



Smooth  
Filter



Elliptical  
Filter

